

Service Manual

Stereo Graphic Equalizer

Equalizer

SH-GE50

Colour

(K) Black Type

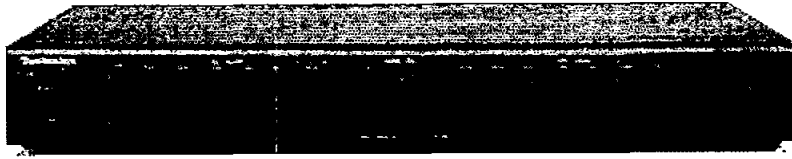

Area

Suffix for Model No.	Area	Colour
(E)	Europe	(K)
(EB)	Great Britain	
(EG)	Germany and Italy	

Specifications

Equalizer Section

Frequency response(center position)	5Hz~100kHz, -3dB
Maximum output voltage	6V(1kHz)
Rated output voltage	1V
Rated total harmonic distortion	0.007%(20Hz~20kHz) 0.005%(1kHz)
Input sensitivity	1V
Signal-to-noise ratio	110dB(IHF'A)
Maximum input voltage	6V
Input impedance	33 kΩ
Gain	0±1 dB
Band level controls	+12dB to -12dB (7 continuous variable elements per channel)

Center frequency

63Hz, 160Hz, 400Hz, 1kHz
2.5kHz, 6.3kHz, 16kHz

General

Power supply	AC 230 - 240 V, 50 Hz
Power consumption	11W
Dimensions (W x H x D)	430 x 80.4 x 192.5 mm (16 ²⁹ / ₃₂ " x 3 ⁷ / ₃₂ " x 7 ¹⁹ / ₃₂ ")
Weight	1.8kg (3.95lb.)

Notes :

- Specifications are subject to change without notice. Weight and dimensions are approximate.
- Total harmonic distortion is measured by the digital spectrum analyzer.

Contents

	Page		Page
CAUTIONS FOR AC MAIN LEADS.....	2	WIRING CONNECTION DIAGRAM.....	11
OPERATION CHECKS.....	3~4	CABINET PARTS LOCATION.....	12
TERMINAL GUIDE OF ICs TRANSISTORS AND DIODES.....	5	REPLACEMENT PARTS LIST.....	13
SCHEMATIC DIAGRAM.....	5~7	RESISTORS & CAPACITORS.....	14
PRINTED CIRCUIT BOARD.....	8~10		

WARNING

This service information is designed for experienced repair technicians only and is not designed for use by the general public. It does not contain warnings or cautions to advise non-technical individuals of potential dangers in attempting to service a product. Products powered by electricity should be serviced or repaired only by experienced professional technicians. Any attempt to service or repair the product or products dealt with in this service information by anyone else could result in serious injury or death.

Technics®

© 1997 Matsushita Electronics (S) Pte. Ltd.
All rights reserved. Unauthorized copying and distribution is a violation of law.

■ Caution for AC Main Leads



(For "EB" area code model only.)

For your safety, please read the following text carefully.

This appliance is supplied with a moulded three pin mains plug for your safety and convenience.

A 5-ampere fuse is fitted in this plug.

Should the fuse need to be replaced please ensure that the replacement fuse has a rating of 5-ampere and that it is approved by ASTA or BSI to BS1362.

Check for the ASTA mark  or the BSI mark  on the body of the fuse.

If the plug contains a removable fuse cover you must ensure that it is refitted when the fuse is replaced.

If you lose the fuse cover, the plug must not be used until a replacement cover is obtained.

A replacement fuse cover can be purchased from your local dealer.

CAUTION !

IF THE FITTED MOULDED PLUG IS UNSUITABLE FOR THE SOCKET OUTLET IN YOUR HOME THEN THE FUSE SHOULD BE REMOVED AND THE PLUG CUT OFF AND DISPOSED OFF SAFELY.

THERE IS A DANGER OF SEVERE ELECTRICAL SHOCK IF THE CUT OFF PLUG IS INSERTED INTO ANY 13-AMPERE SOCKET.

If a new plug is to be fitted, please observe the wiring code as shown below.

If in any doubt please consult a qualified electrician.

IMPORTANT

The wires in this mains lead are coloured in accordance with the following code:

Blue: Neutral
Brown: Live

As these colours may not correspond with the coloured markings identifying the terminals in your plug, proceed as follows:

The wire which is coloured Blue must be connected to the terminal which is marked with the letter N or coloured Black or Blue.

The wire which is coloured Brown must be connected to the terminal which is marked with the letter L or coloured Brown or Red.

WARNING: DO NOT CONNECT EITHER WIRE TO THE EARTH TERMINAL WHICH IS MARKED WITH THE LETTER E, BY THE EARTH SYMBOL \perp OR COLOURED GREEN OR GREEN/YELLOW.

THIS PLUG IS NOT WATERPROOF—KEEP DRY.

Before use

Remove the connector cover.

How to replace the fuse

The location of the fuse differ according to the type of AC mains plug (figures A and B). Confirm the AC mains plug fitted and follow the instructions below.

Illustrations may differ from actual AC mains plug.

1. Open the fuse cover with a screwdriver.

Figure A

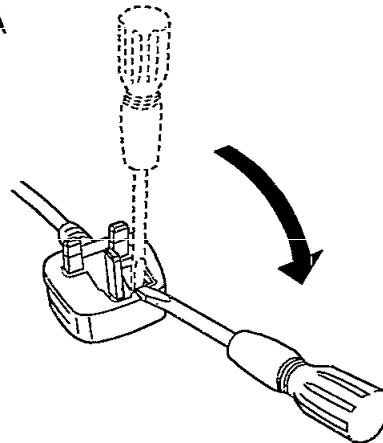
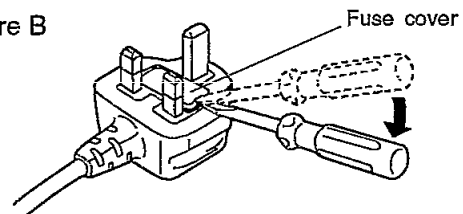

Figure B



2. Replace the fuse and close or attach the fuse cover.

Figure A

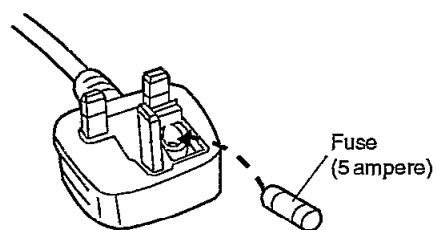
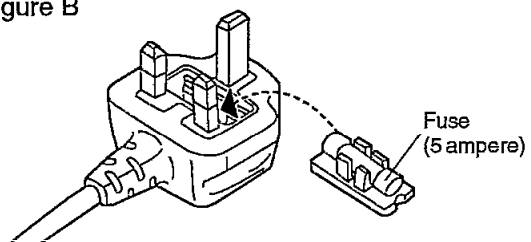

Figure B



■ Operation Checks

"ATTENTION SERVICER" Some chassis components may have sharpe edges. Be careful when disassembling and serving.

1. This section describes procedures for checking the operation of the major printed circuit boards .
2. For reassembly after operation checks or replacement, reverse the respective procedures.
Special reassembly procedures are described only when required.
3. Select items from the following index when checks or replacement are required.

• Contents

- Checking Procedure for Major P.C.B.

page
3 ~ 4

■ Checking Procedure for Major P.C.B.

1. Checking of the Equalizer P.C.B.

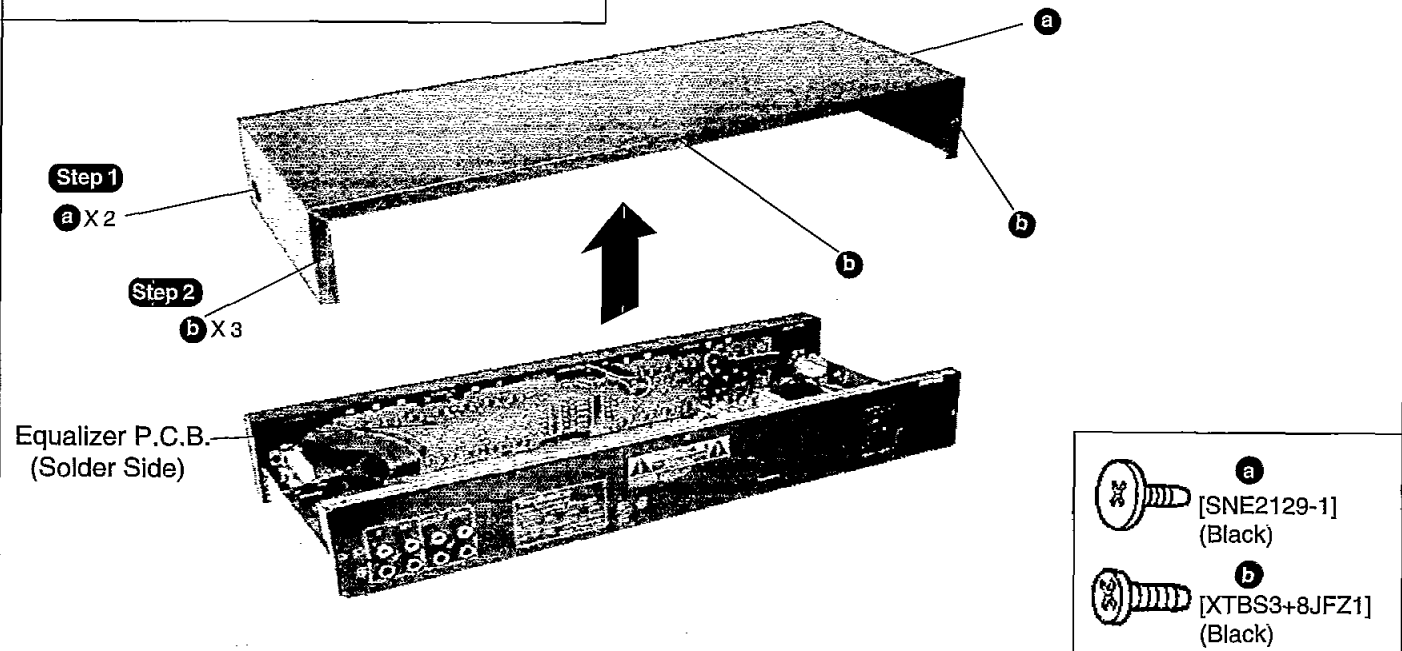

2. To remove the front panel from bottom chassis

- Step 1
Remove the top cabinet.
- Step 3
Push the 3 catch and pull the frontcabinet simultaneously in the direction of arrow.

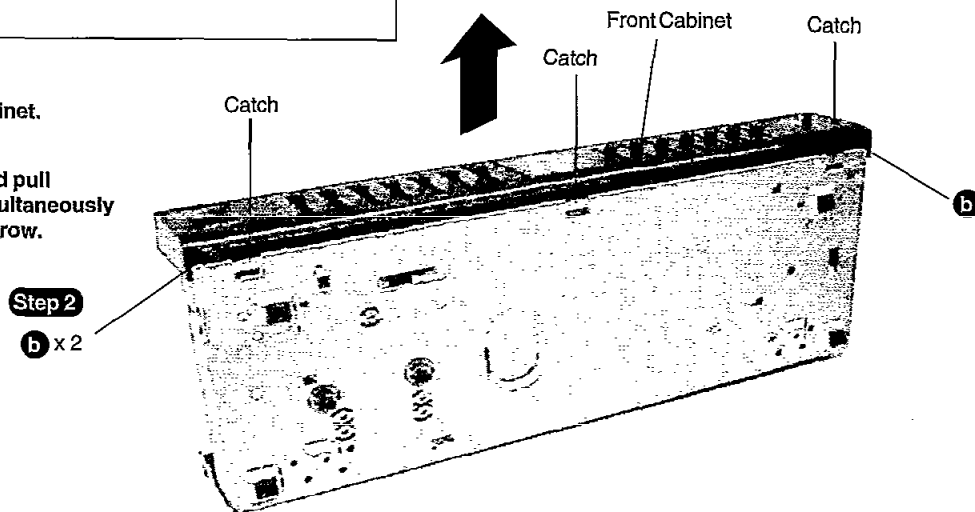

3. To remove Equalizer P.C.B.

Step 1

Remove the top cabinet.

Step 2

Remove the front cabinet.

Step 4

Remove the Equalizer P.C.B. in the direction of arrow ①

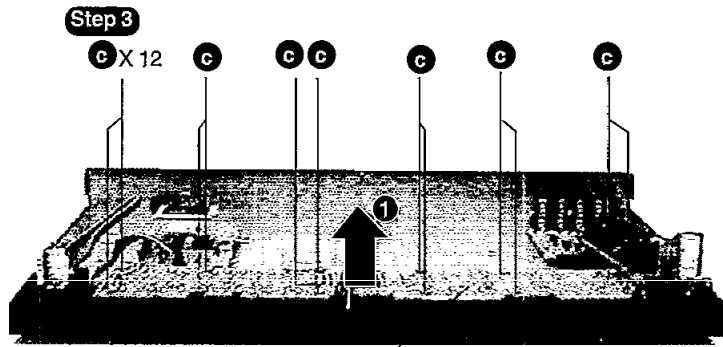

Equalizer P.C.B.



4. Checking of Input Selector P.C.B., Meter P.C.B. and Power Switch P.C.B.

Step 1

Follow procedure 3

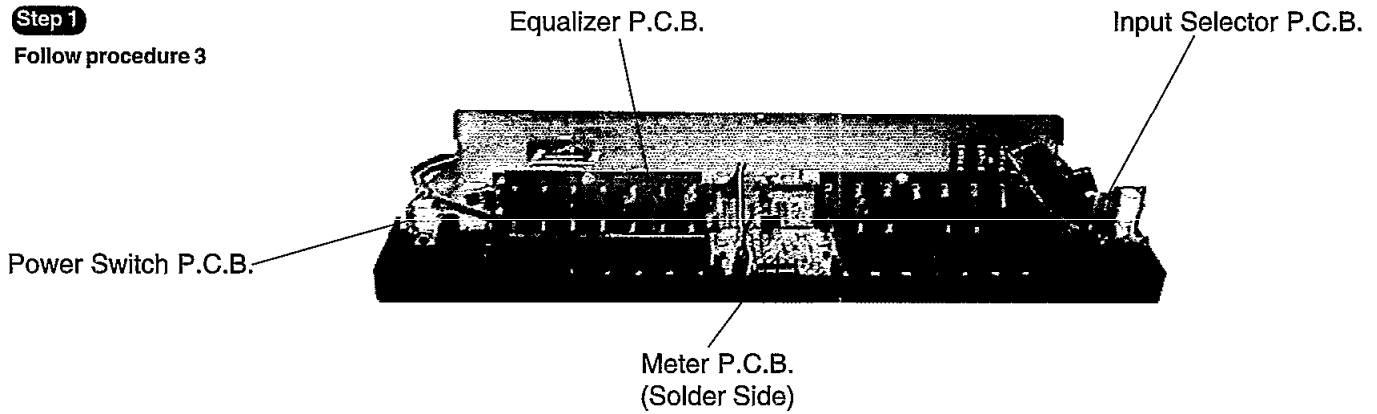

5. Checking of Power Supply P.C.B. and In/Output Terminal P.C.B.

Step 1

Remove the top cabinet.

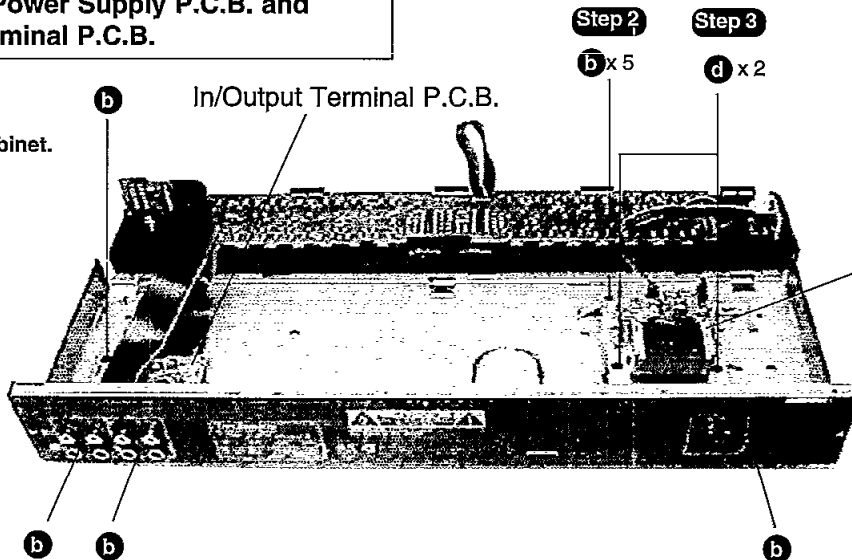

Step 2

b x 5



Step 3

d x 2

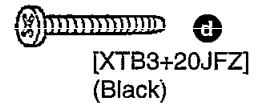
Power Supply P.C.B.

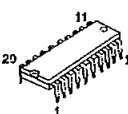
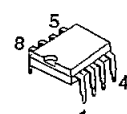
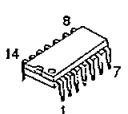
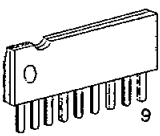

Terminal Guide of ICs, Transistors and Diodes

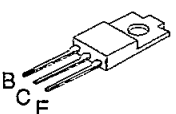
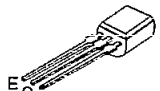
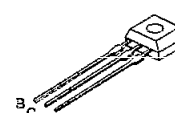
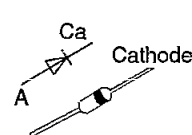
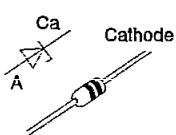
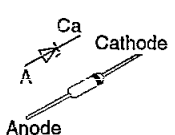
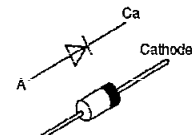
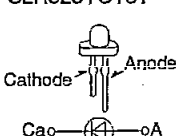
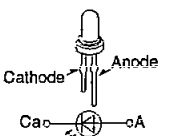
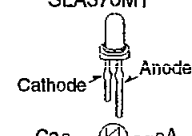
M5229P 	M5218AP 	MLC4066BH 	BA6144 	RVTDT143XST 2SA933SSTA 2SC1740SSTA 	2SD2374PQAU 
2SB621AQSTA 	2SD1915FTA 	MA165TA 	MA2110BLF 	MTZJ13BTA 	RL1N4003NO2 
SLR325MCT31 SLR325YCT31 	SLR342VC 	SLA370LT SLA370MT 			

Schematic Diagram

(All schematic diagrams may be modified at any time with the development of new technology)

Note :

- S1 : Power switch
- S201 : Input Selector switch
- VR201 & VR202 : Equaliser control (63Hz)
- VR203 & VR204 : Equaliser control (1 60Hz)
- VR205 & VR206 : Equaliser control (400Hz)
- VR207 & VR208 : Equaliser control (1kHz)
- VR209 & VR210 : Equaliser control (2.5kHz)
- VR2011 & VR2012 : Equaliser control (6.3kHz)
- VR2013 & VR2014 : Equaliser control (16kHz)

Signal line



•The voltage value and waveforms are the reference voltage of this unit measured by DC electronic voltmeter (high impedance) and oscilloscope on the basis of chassis.
Accordingly, there may arise some error in voltage values and waveforms depending upon the internal impedance of the tester or the measuring unit.

Importance safety notice:

Components identified by  mark have special characteristics important for safety. Furthermore, special parts which have purposes of fire-retardant (resistors), high-quality sound (capacitors), low-noise (resistors), etc. are used. When replacing any of components, be sure to use only manufacturer's specified parts shown in the parts list.

Caution !

- IC, LSI and VLSI are sensitive to static electricity.
- Secondary trouble can be prevented by taking care during repair.
- Cover the parts boxes made of plastics with aluminium foil.
- Ground the soldering iron.
- Do not touch the pins of IC, LSI or VLSI with fingers directly.
- Put a conductive mat on the work table.

Schematic Diagram

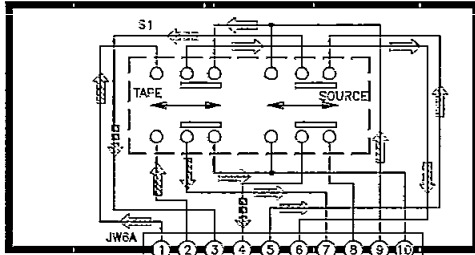

E INPUT SWITCH CIRCUIT

A IN/OUTPUT TERMINAL/BUFFER AMP CIRCUIT

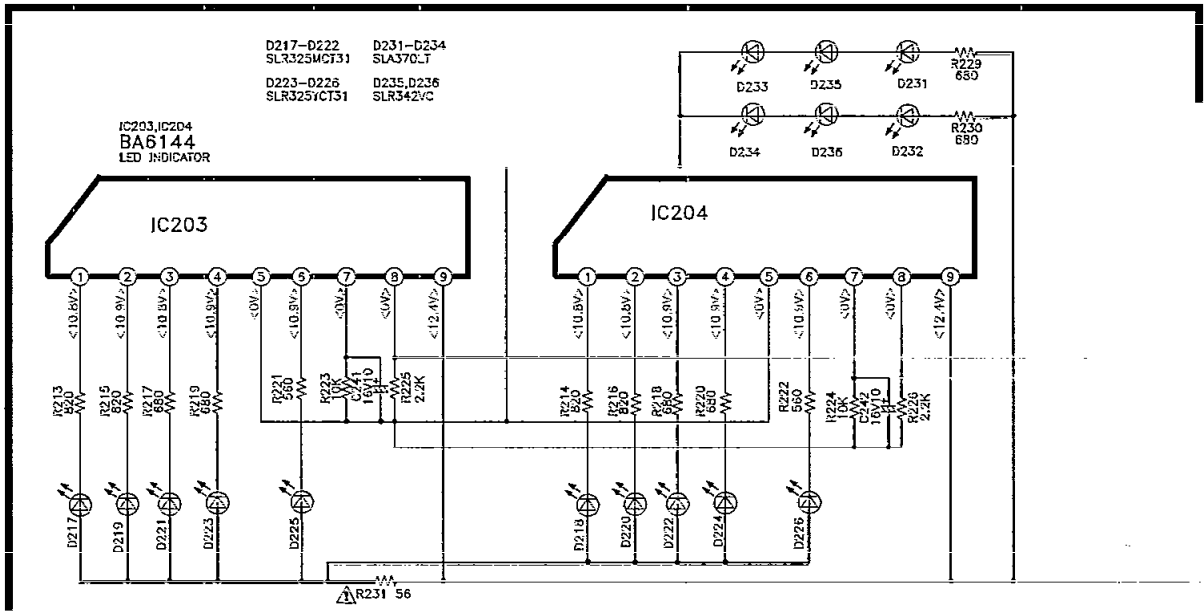
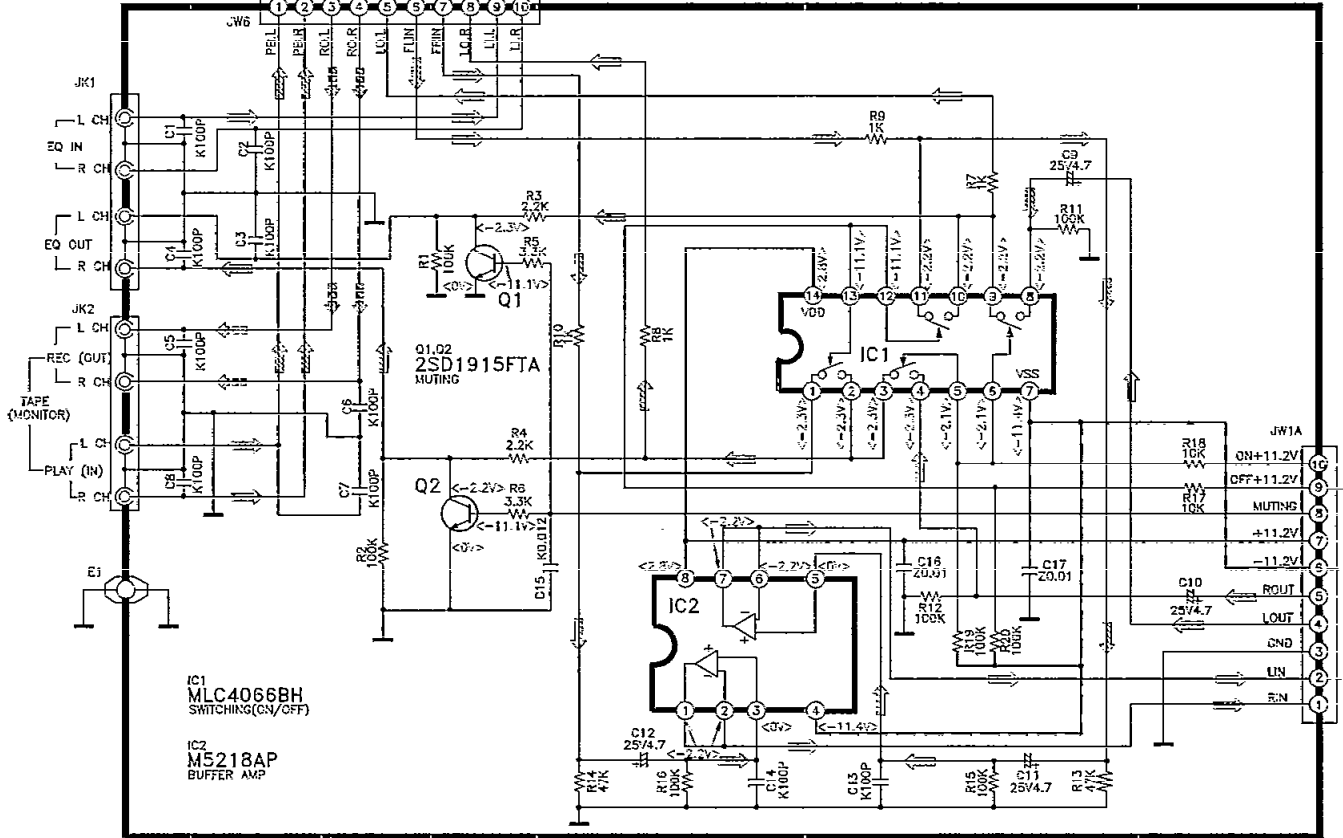

F METER CIRCUIT

C B.P FILTER AMP/BAND LEVEL CONTROLS CIRCUIT

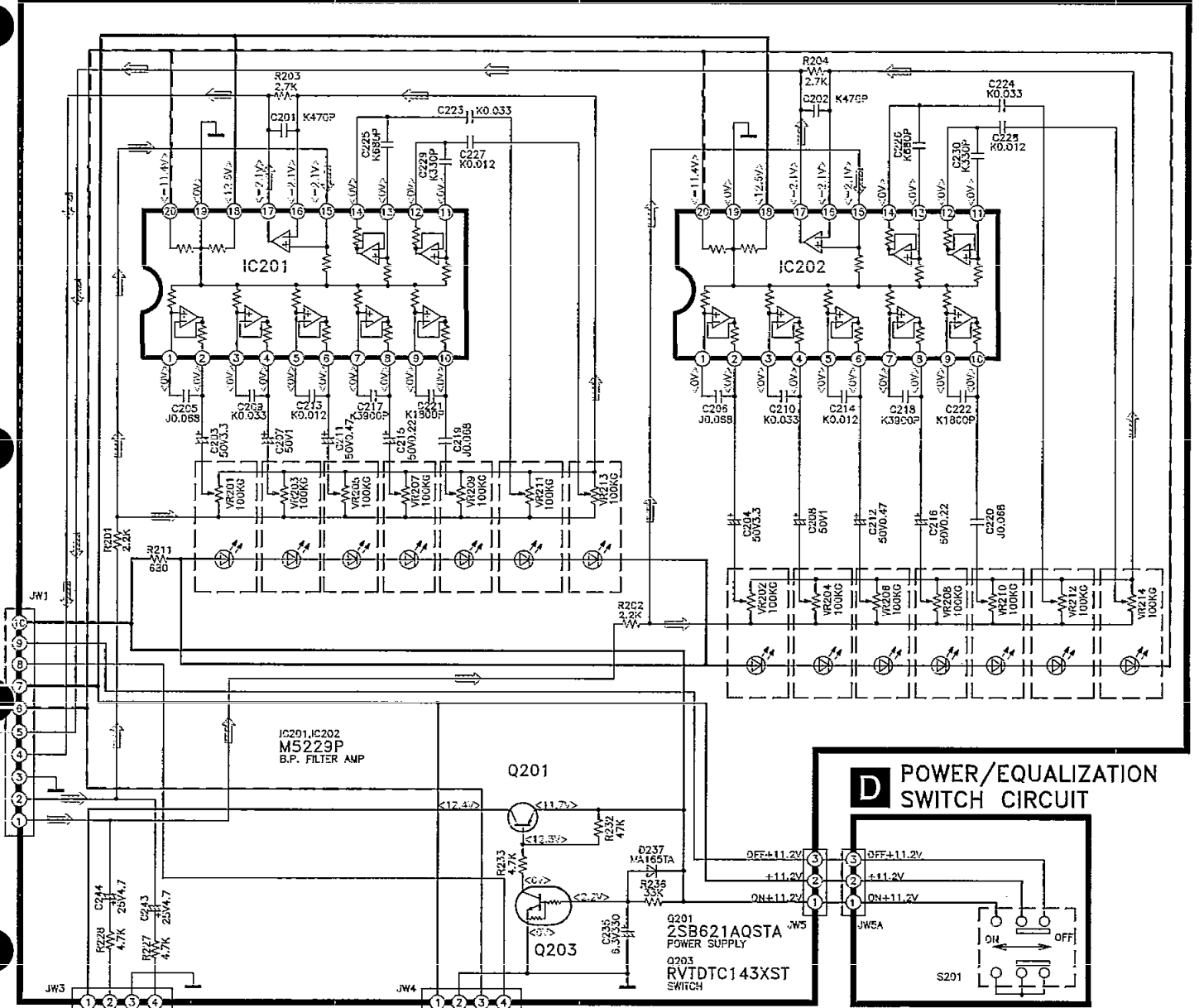

D POWER/EQUALIZATION SWITCH CIRCUIT

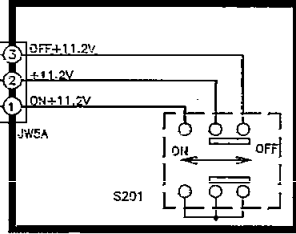

B POWER CIRCUIT

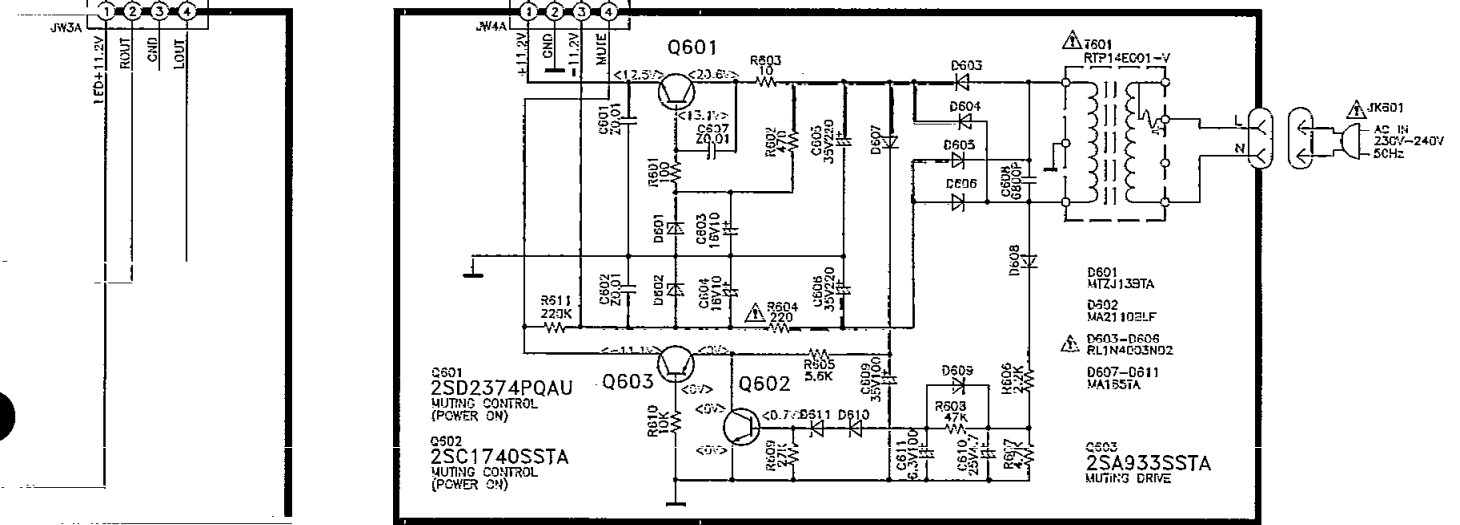

■ Printed Circuit Board

■ B.P FILTER AMP/BMP BAND LEVEL CONTROLS P.C.B. (REP2485C-M)

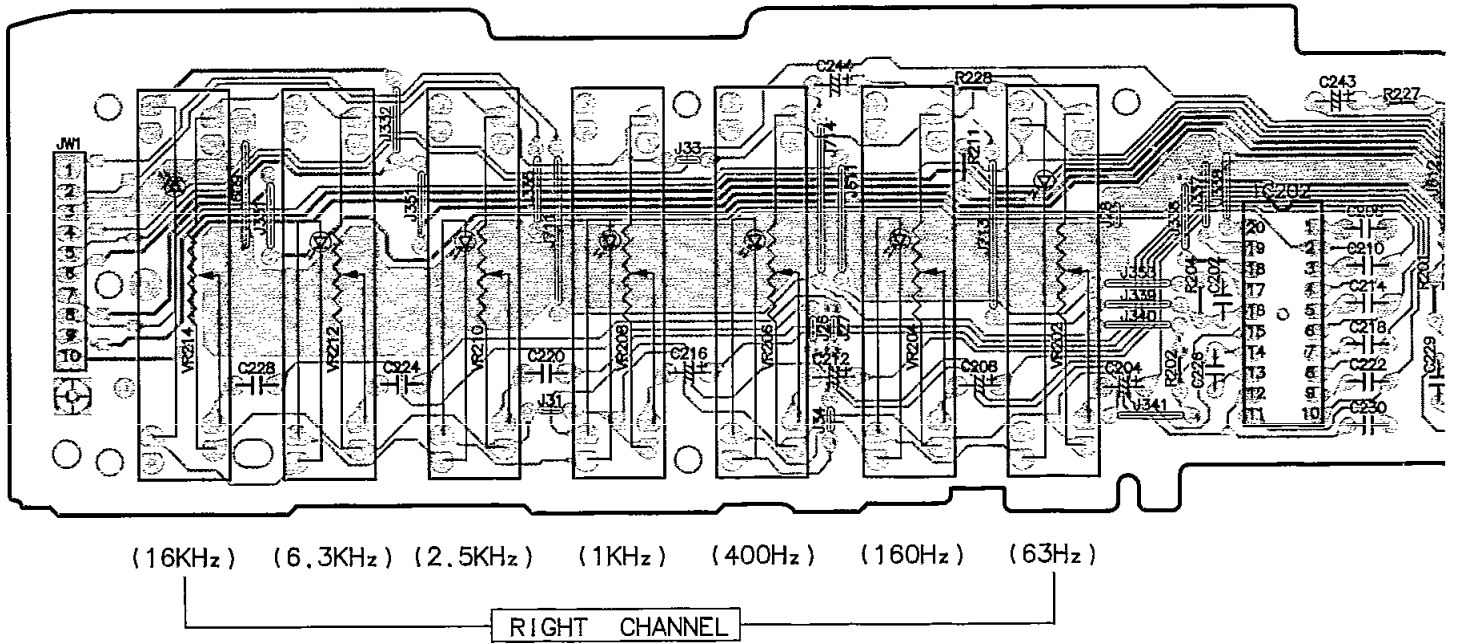

■ IN/OUTPUT TERMINAL/BUFFER AMP P.C.B. (REP2485C-M)

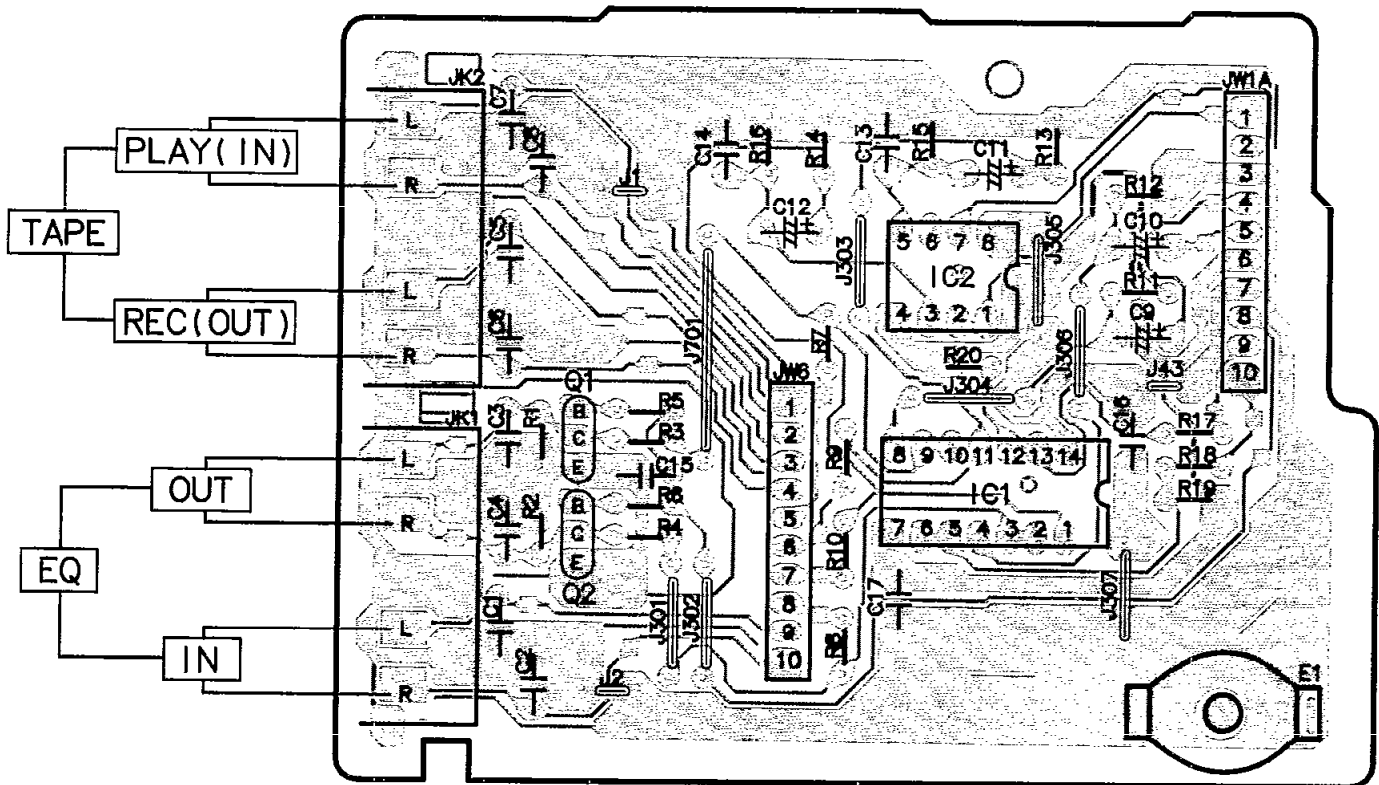

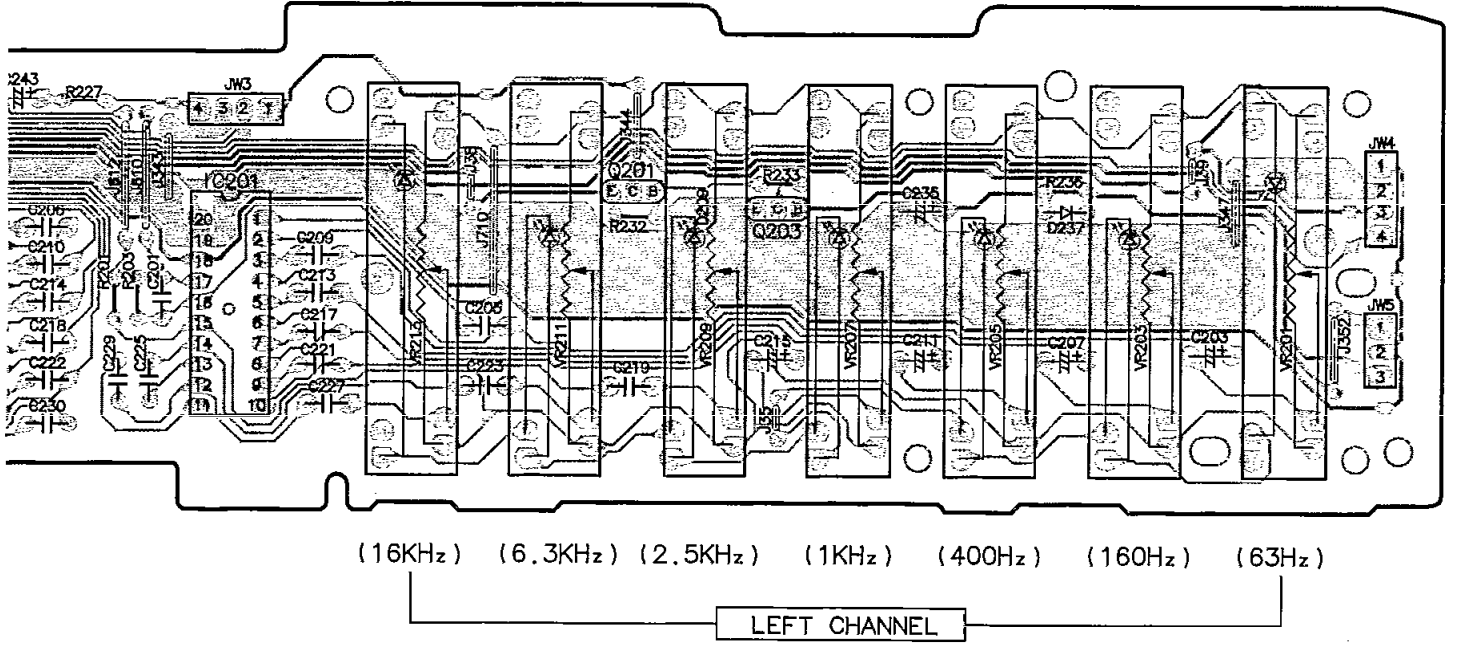

B POWER P.C.B. (REP2485C-M)

CAUTION
 RISK OF ELECTRIC SHOCK
 AC voltage line. Please do not touch this portion.

AC IN ~
 230V-240V
 50Hz

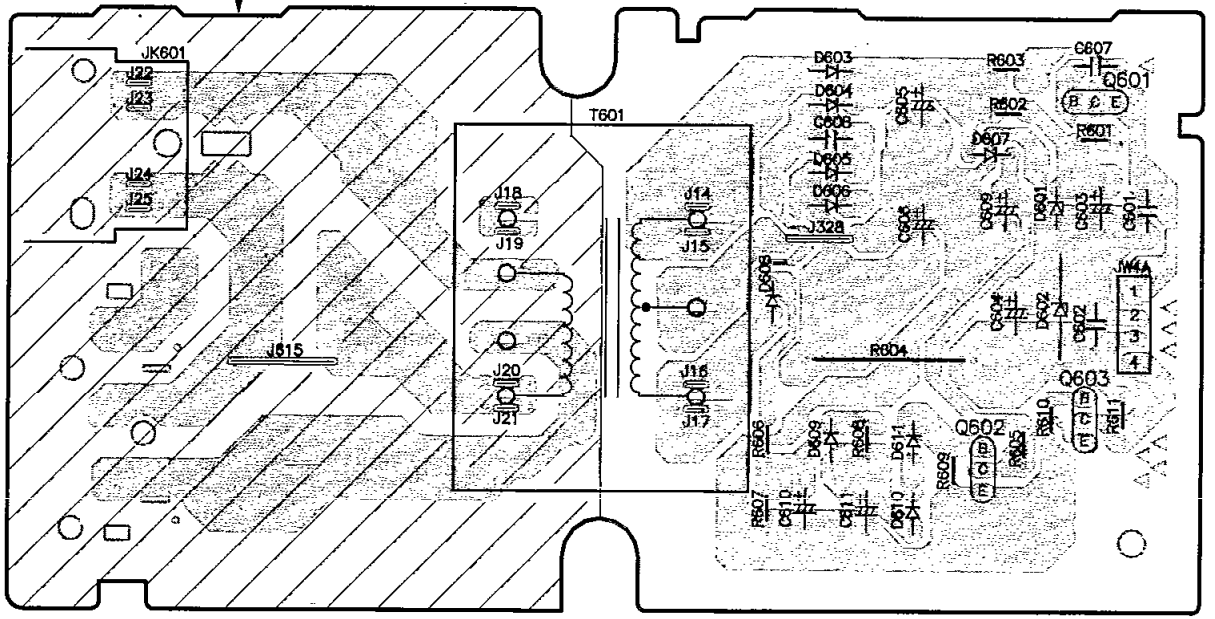

D POWER/EQUALIZATION SWITCH P.C.B. (REP2485C-M)

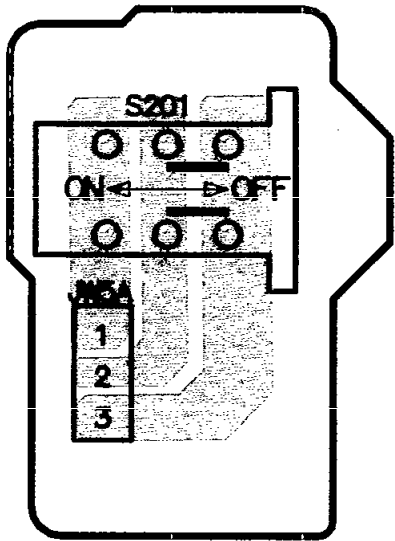

E INPUT SWITCH P.C.B. (REP2485C-M)

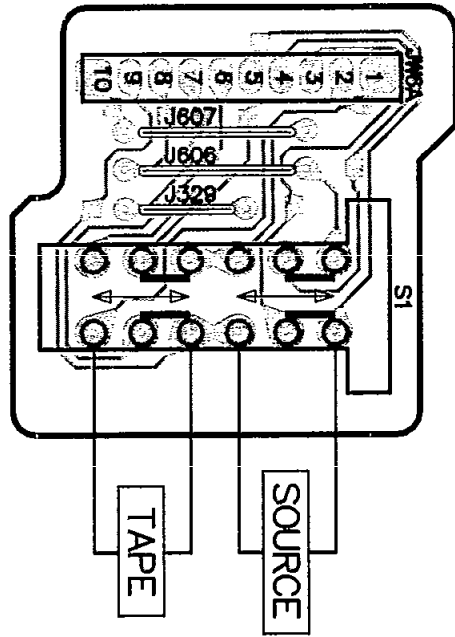

F METER P.C.B. (REP2485C-M)

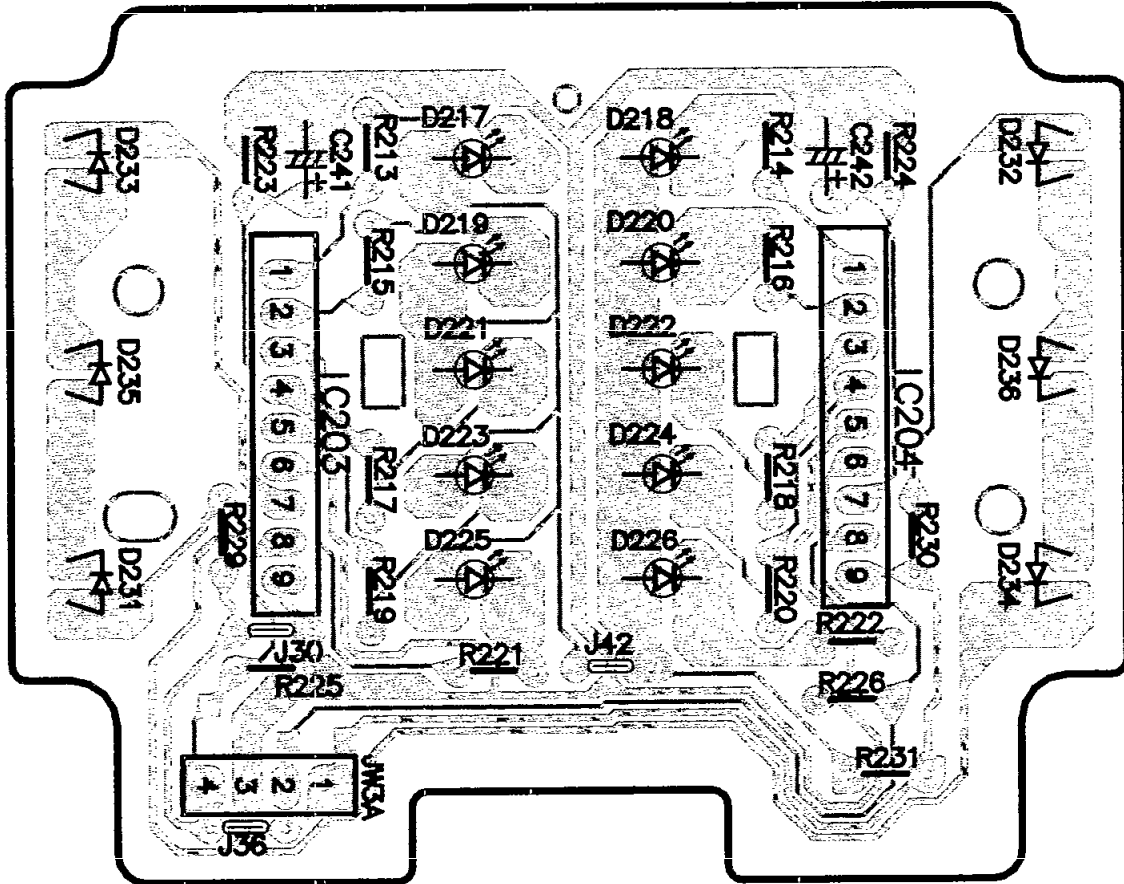

■ Wiring Connection Diagram

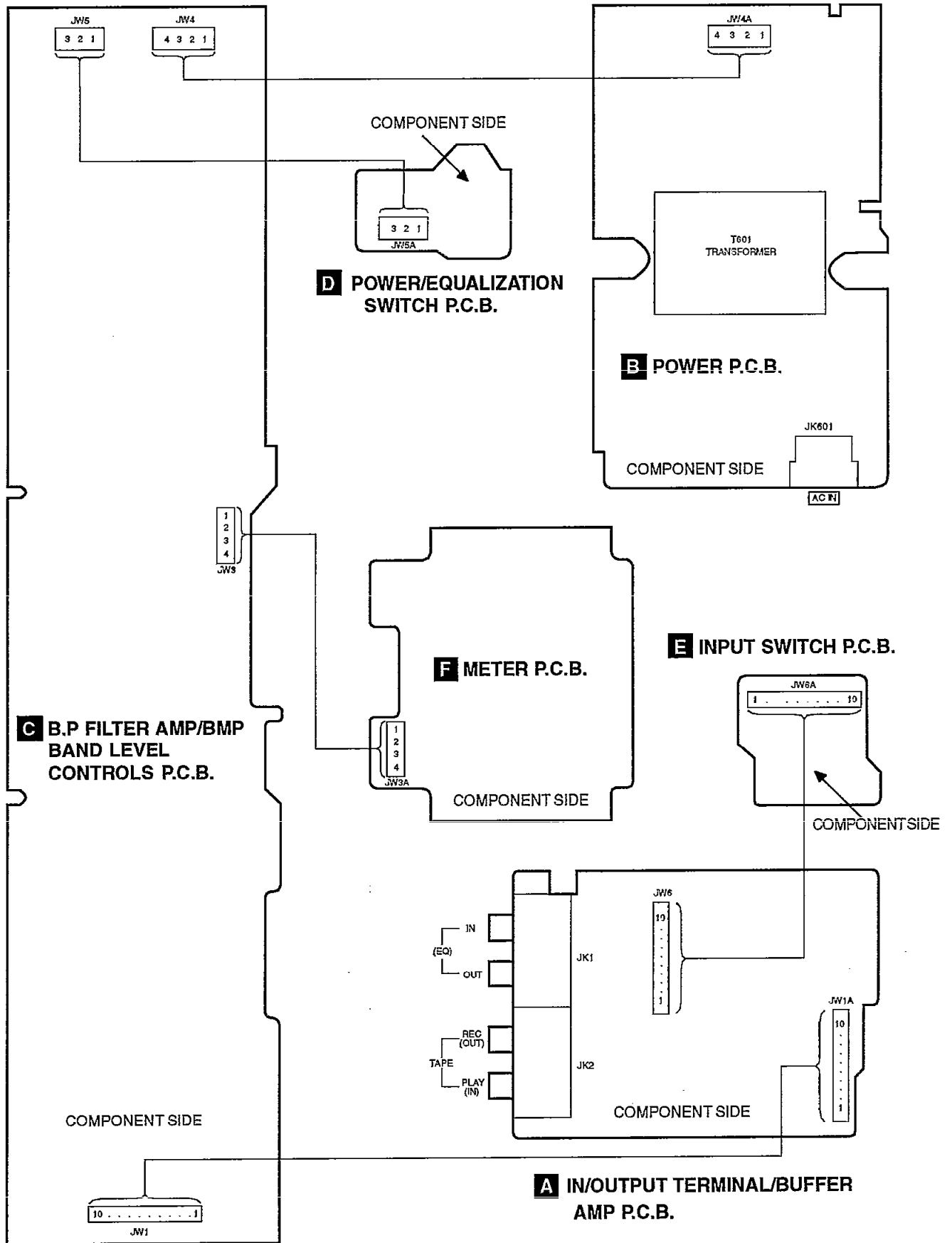

■ Cabinet Parts Location

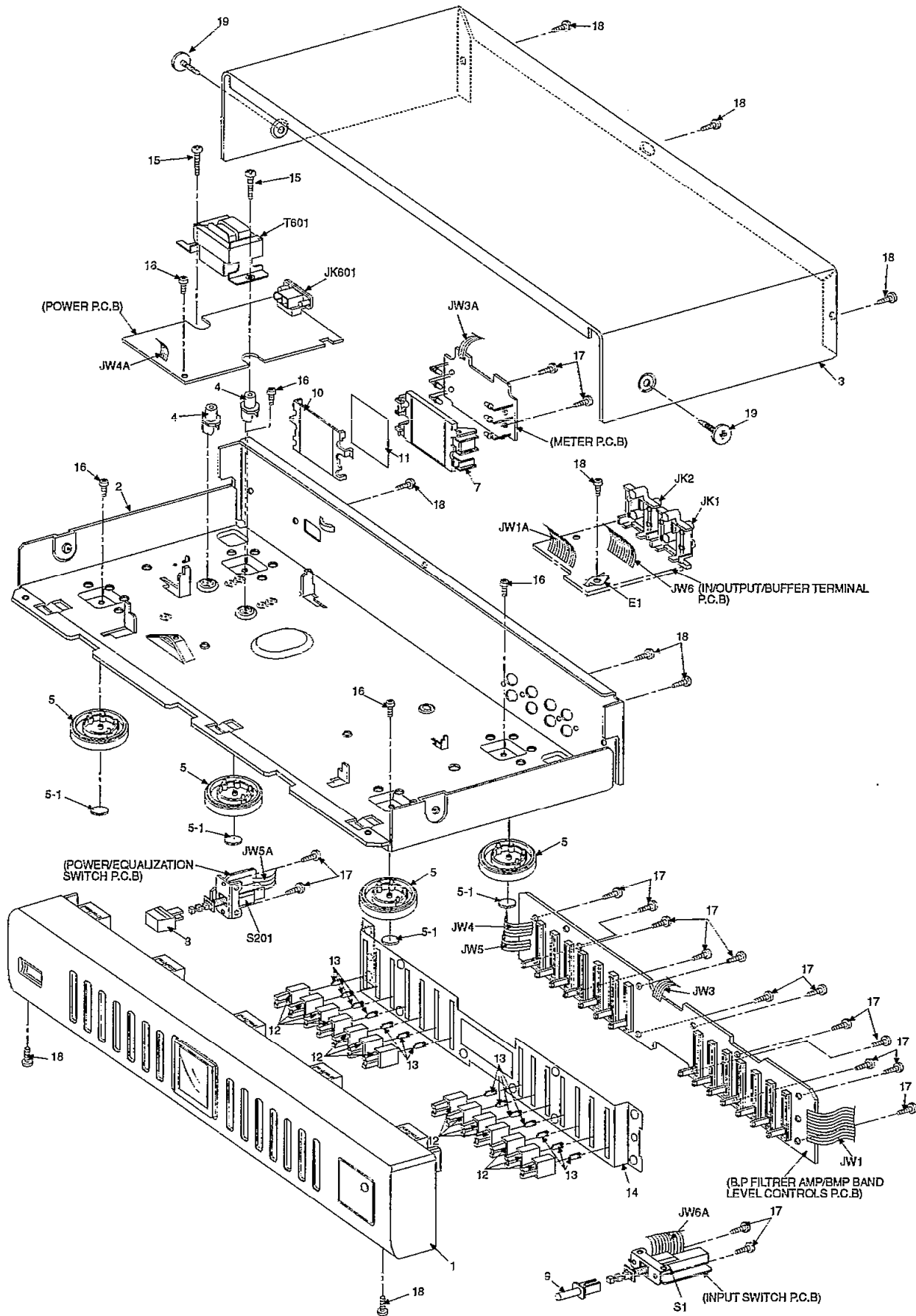





■ Replacement Parts List

Notes: * Important safety notice :

Components identified by  mark have special characteristics important for safety.

Furthermore, special parts which have purposes of fire-retardant (resistors), high-quality sound (capacitors), low-noise (resistors), etc. are used. When replacing any of components, be sure to use only manufacturer's specified parts shown in the parts list.

* [M] in Remarks column indicates parts that are supplied by MESA.

RefNo.	Part No.	Part Name & Description	Remarks	RefNo.	Part No.	Part Name & Description	Remarks	RefNo.	Part No.	Part Name & Description	Remarks	
		CABINET AND CHASSIS					DIODES					
1	RFKQHG50EK	FRONT PANEL ASS'Y	[M]	D217	SLR325MCT31	DIODE	[M]	VR210	EWANWQJ15G15	VARIABLE RESISTOR	[M]	
2	SGPK420-7B	BOTTOM CHASSIS	[M]EG E	D218	SLR325MCT31	DIODE	[M]	VR211	EWANWQJ15G15	VARIABLE RESISTOR	[M]	
2	SGPK420-7C	BOTTOM CHASSIS	[M]EB	D219	SLR325MCT31	DIODE	[M]	VR212	EWANWQJ15G15	VARIABLE RESISTOR	[M]	
3	SKCK200K99	TOP CABINET	[M]	D220	SLR325MCT31	DIODE	[M]	VR213	EWANWQJ15G15	VARIABLE RESISTOR	[M]	
4	RKQ0089-J	PCB HOLDER	[M]	D221	SLR325MCT31	DIODE	[M]	VR214	EWANWQJ15G15	VARIABLE RESISTOR	[M]	
5	RKA0079-A	LEG	[M]	D222	SLR325MCT31	DIODE	[M]			SWITCHES		
5-1	RMG0270-K	LEG CUSHION	[M]	D223	SLR325YCT31	DIODE	[M]	G1	RSP2D015-A	SW, POWER	[M]	
7	RMN0433	LED CASE	[M]	D224	SLR325YCT31	DIODE	[M]	S201	RSP2B022-A	SW, INPUT SELECTOR	[M]	
8	RGU0890-K	POWER BUTTON	[M]	D225	SLR325YCT31	DIODE	[M]			COILS & TRANSFORMERS		
9	RGU1330-K	VCR2 BUTTON	[M]	D226	SLR325YCT31	DIODE	[M]	T601	RTP1J4E001-V	TRANSFORMER	[M] 	
10	RGL0361-Q	LIGHT GUIDE	[M]	D231	SLA370LT	DIODE	[M]			EARTH TERMINAL		
11	RKW0509-K	LED SHEET	[M]	D232	SLA370MT	DIODE	[M]	E1	SNE1004-2	EARTH TERMINAL	[M]	
12	SBWK27	VOLUME KNOB	[M]	D233	SLA370MT	DIODE	[M]			JACKS		
13	SBZK33	LIGHT GUIDE	[M]	D234	SLA370LT	DIODE	[M]	JK1	SJF3069N	JK, LINE IN	[M]	
14	RMF0248	BLIND SHEET	[M]	D235	SLR342VC	DIODE	[M]	JK2	SJF3069N	JK, LINE IN	[M]	
15	XTB3+20JFZ	SCREW	[M]	D236	SLR342VC	DIODE	[M]	JK801	SJS9236-1	JK, AC INLET	[M] 	
16	XTB3+6G	SCREW (FOOT)	[M]	D237	MA165TA	DIODE	[M]			PACKING MATERIALS		
17	XTB326+10J	SCREW (FRONT)	[M]	D601	MTZJ138TA	DIODE	[M]	P1	RPG3430	PACKING CASE	[M]E	
18	XTB33+8JFZ1	SCREW	[M]	D602	MA2110BLF	DIODE	[M]	P1	RPG3431	PACKING CASE	[M]EB	
19	SNE2129-1	SCREW (CABINET)	[M]	D603	RL1N4003N02	DIODE	[M] 	P1	RPG3623	PACKING CASE	[M]EG	
				D604	RL1N4003N02	DIODE	[M] 	P2	SPPK51	MIRAMAT BAG	[M]	
		INTEGRATED CIRCUITS			D605	RL1N4003N02	DIODE	[M] 	P3	SPSK121-1	POLYFOAM (L)	[M]
IC1	MLC4066BH	IC, EQ	[M]	D606	RL1N4003N02	DIODE	[M] 	P4	SPSK122-2	POLYFOAM (R)	[M]	
IC2	M5218AP	IC, BUFFER AMP	[M]	D607	MA165TA	DIODE	[M]			ACCESSORIES		
IC201	M5229P	IC, FILTER	[M]	D608	MA165TA	DIODE	[M]	A1	RJA0019-2A	AC CORD 	[M]EG E	
IC202	M5229P	IC, FILTER	[M]	D609	MA165TA	DIODE	[M]	A1	RJA0038-U	AC CORD 	[M]EB	
IC203	BA6144	IC, MASTER	[M]	D610	MA165TA	DIODE	[M]	A2	RJL2P004B08	STEREO CABLE	[M]	
IC204	BA6144	IC, MASTER	[M]	D611	MA165TA	DIODE	[M]	A3	RFKSHGE50EBK	INST'L MANUAL ASS'Y	[M]EG	
						VARIABLE RESISTORS			A3	RFKSHGE50EK	INST'L MANUAL ASS'Y	[M]E
		TRANSISTORS			VR201	EWANWQJ15G15	VARIABLE RESISTOR	[M]	A3	RQT3004-B	O/I BOOK	[M]EB
Q1	2SD1915FTA	TRANSISTOR	[M]	VR202	EWANWQJ15G15	VARIABLE RESISTOR	[M]					
Q2	2SD1915FTA	TRANSISTOR	[M]	VR203	EWANWQJ15G15	VARIABLE RESISTOR	[M]					
Q201	2SB621AQSTA	TRANSISTOR	[M]	VR204	EWANWQJ15G15	VARIABLE RESISTOR	[M]					
Q203	RVTDT143XST	TRANSISTOR	[M]	VR205	EWANWQJ15G15	VARIABLE RESISTOR	[M]					
Q601	2SD2974PQAU	TRANSISTOR	[M]	VR206	EWANWQJ15G15	VARIABLE RESISTOR	[M]					
Q602	2SC1740SSSTA	TRANSISTOR	[M]	VR207	EWANWQJ15G15	VARIABLE RESISTOR	[M]					
Q603	2SA933SSSTA	TRANSISTOR	[M]	VR208	EWANWQJ15G15	VARIABLE RESISTOR	[M]					
				VR209	EWANWQJ15G15	VARIABLE RESISTOR	[M]					

Resistors & Capacitors

Notes : * Important safety notice:

Components identified by Δ mark have special characteristics important for safety.

Furthermore, special parts which have purposes of fire-retardant (resistors), high-quality sound (capacitors), low-noise (resistors), etc. are used. When replacing any of components, be sure to use only manufacturer's specified parts shown in the parts list.

* Capacitor values are in microfarad (μ F) unless specified otherwise, P=Pico-farads (pF) F=Farads (F)

* Resistors values are in ohms, unless specified otherwise, 1K=1,000(OHM), 1M=1,000K(OHM)

RefNo	PartNo.	Values&Remarks	RefNo.	PartNo.	Values&Remarks	RefNo.	PartNo.	Values&Remarks	RefNo.	PartNo.	Values&Remarks
	RESISTORS										
R1	ERDS2TJ104T	100K 1/4W [M]	R229	ERDS2TJ681T	680 1/4W [M]	C207	ECEA1HKA010B	1 50V [M]			
R2	ERDS2TJ104T	100K 1/4W [M]	R230	ERDS2TJ681T	680 1/4W [M]	C208	ECEA1HKA010B	1 50V [M]			
R3	ERDS2TJ222T	2.2K 1/4W [M]	R231	ERDS1FVJ560T Δ	56 1/2W [M]	C209	ECFR1E333KR	0.033 25V [M]			
R4	ERDS2TJ222T	2.2K 1/4W [M]	R232	ERDS2TJ473T	47K 1/4W [M]	C210	ECFR1E333KR	0.033 25V [M]			
R5	ERDS2TJ332T	3.3K 1/4W [M]	R233	ERDS2TJ472T	4.7K 1/4W [M]	C211	ECEA1HKAR47B	0.47 50V [M]			
R6	ERDS2TJ332T	3.3K 1/4W [M]	R236	ERDS2TJ333T	33K 1/4W [M]	C212	ECEA1HKAR47B	0.47 50V [M]			
R7	ERDS2TJ102T	1K 1/4W [M]	R601	ERDS2TJ101T	100 1/4W [M]	C213	ECFR1E123KR	0.012 25V [M]			
R8	ERDS2TJ102T	1K 1/4W [M]	R602	ERDS2TJ471T	470 1/4W [M]	C214	ECFR1E123KR	0.012 25V [M]			
R9	ERDS2TJ102T	1K 1/4W [M]	R603	ERD2FCVCG1C0T	10 1/4W [M]	C215	ECEA1HKAR22B	0.22 50V [M]			
R10	ERDS2TJ102T	1K 1/4W [M]	R604	ERG2ANJP221H Δ	220 2W [M]	C216	ECEA1HKAR22B	0.22 50V [M]			
R11	ERDS2TJ104T	100K 1/4W [M]	R605	ERDS2TJ562T	5.6K 1/4W [M]	C217	ECBT1C392KR5	3900P 16V [M]			
R12	ERDS2TJ104T	100K 1/4W [M]	R606	ERDS2TJ222T	2.2K 1/4W [M]	C218	ECBT1C392KR5	3900P 16V [M]			
R13	ERDS2TJ473T	47K 1/4W [M]	R607	ERDS2TJ472T	4.7K 1/4W [M]	C219	ECQV1H683JM3	0.068 50V [M]			
R14	ERDS2TJ473T	47K 1/4W [M]	R608	ERDS2TJ473T	47K 1/4W [M]	C220	ECQV1H683JM3	0.068 50V [M]			
R15	ERDS2TJ104T	100K 1/4W [M]	R609	ERDS2TJ273T	27K 1/4W [M]	C221	ECBT1C182KR5	1800P 16V [M]			
R16	ERDS2TJ104T	100K 1/4W [M]	R610	ERDS2TJ103T	10K 1/4W [M]	C222	ECBT1C182KR5	1800P 16V [M]			
R17	ERDS2TJ103T	10K 1/4W [M]	R611	ERDS2TJ224T	220K 1/4W [M]	C223	ECFR1E333KR	0.033 25V [M]			
R18	ERDS2TJ103T	10K 1/4W [M]				C224	ECFR1E333KR	0.033 25V [M]			
R19	ERDS2TJ104T	100K 1/4W [M]		CAPACITORS		C225	ECBT1H681KB5	680P 50V [M]			
R20	ERDS2TJ104T	100K 1/4W [M]	C1	ECBT1H101KB5	100P 50V [M]	C226	ECBT1H681KB5	680P 50V [M]			
R201	ERDS2TJ222T	2.2K 1/4W [M]	C2	ECBT1H101KB5	100P 50V [M]	C227	ECFR1E123KR	0.012 25V [M]			
R202	ERDS2TJ222T	2.2K 1/4W [M]	C3	ECBT1H101KB5	100P 50V [M]	C228	ECFR1E123KR	0.012 25V [M]			
R203	ERDS2TJ272T	2.7K 1/4W [M]	C4	ECBT1H101KB5	100P 50V [M]	C229	ECBT1H331KB5	330P 50V [M]			
R204	ERDS2TJ272T	2.7K 1/4W [M]	C5	ECBT1H101KB5	100P 50V [M]	C230	ECBT1H331KB5	330P 50V [M]			
R211	ERDS2TJ681T	680 1/4W [M]	C6	ECBT1H101KB5	100P 50V [M]	C235	ECEA0JKA331Q	330 6.3V [M]			
R213	ERDS2TJ821T	820 1/4W [M]	C7	ECBT1H101KB5	100P 50V [M]	C241	ECEA1CKA100B	10 16V [M]			
R214	ERDS2TJ821T	820 1/4W [M]	C8	ECBT1H101KB5	100P 50V [M]	C242	ECEA1CKA100B	10 16V [M]			
R215	ERDS2TJ821T	820 1/4W [M]	C9	ECEA1EKA4R7B	4.7 25V [M]	C243	ECEA1EKA4R7B	4.7 25V [M]			
R216	ERDS2TJ821T	820 1/4W [M]	C10	ECEA1EKA4R7B	4.7 25V [M]	C244	ECEA1EKA4R7B	4.7 25V [M]			
R217	ERDS2TJ681T	680 1/4W [M]	C11	ECEA1EKA4R7B	4.7 25V [M]	C601	ECBT1E103ZF5	0.01 25V [M]			
R218	ERDS2TJ681T	680 1/4W [M]	C12	ECEA1EKA4R7B	4.7 25V [M]	C602	ECBT1E103ZF5	0.01 25V [M]			
R219	ERDS2TJ681T	680 1/4W [M]	C13	ECCR1H101K5	100P 50V [M]	C603	ECEA1CKA100B	10 16V [M]			
R220	ERDS2TJ681T	680 1/4W [M]	C14	ECCR1H101K5	100P 50V [M]	C604	ECEA1CKA100B	10 16V [M]			
R221	ERDS2TJ561T	560 1/4W [M]	C15	ECFR1E123KR	0.012 25V [M]	C605	ECA1VM221B	220 35V [M]			
R222	ERDS2TJ561T	560 1/4W [M]	C16	ECBT1E103ZF5	0.01 25V [M]	C606	ECA1VM221B	220 35V [M]			
R223	ERDS2TJ103T	10K 1/4W [M]	C17	ECBT1E103ZF5	0.01 25V [M]	C607	ECBT1E103ZF5	0.01 25V [M]			
R224	ERDS2TJ103T	10K 1/4W [M]	C201	ECBT1H471KB5	470P 50V [M]	C608	ECKR2H6832PE	6800P 500V [M]			
R225	ERDS2TJ222T	2.2K 1/4W [M]	C202	ECBT1H471KB5	470P 50V [M]	C609	ECA1VM101B	100 35V [M]			
R226	ERDS2TJ222T	2.2K 1/4W [M]	C203	ECEA1HKA3R3B	3.3 50V [M]	C610	ECEA1EKA4R7B	4.7 25V [M]			
R227	ERDS2TJ472T	4.7K 1/4W [M]	C204	ECEA1HKA3R3B	3.3 50V [M]	C611	ECEA0JKA101B	100 6.3V [M]			
R228	ERDS2TJ472T	4.7K 1/4W [M]	C205	ECQV1H683JM3	0.068 50V [M]						
			C206	ECQV1H683JM3	0.068 50V [M]						



343